

# LISTA DE APLICACIONES - BUYERS GUIDE

## 78BD3324-1



Weight: 12.552

O.E.M.	MAKE
7L6 615 302	VW
7L6 615 302 E	VW
7L6 615 302 K	VW
7L8 615 302	VW
955 351 402 50	PORSCHE

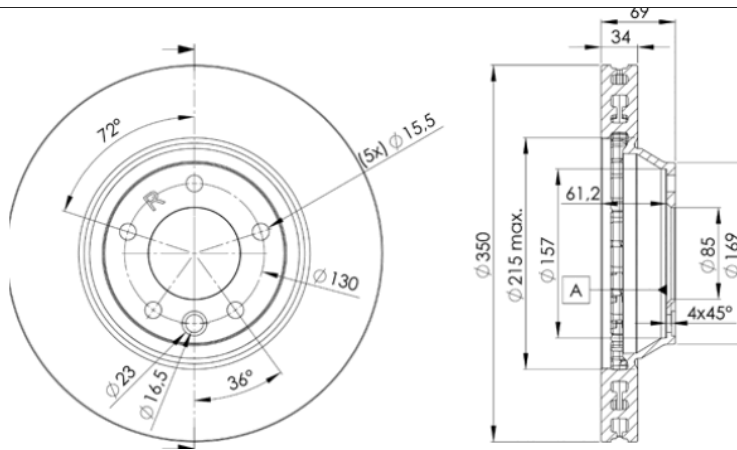

## 78BD3324-1

**E1** 90R-02C0452/0091



Ø350x34x69

MAKE
AUDI
PORSCHE
VW



Trac.	CC	Kw	CV
-------	----	----	----



Front / Rear

### AUDI

Q7 (4LB) 03.06-01.16						SUV Van (Luxury Crossover SUV-J Segment)			
3.0 TFSI quattro	PR 1LF	Gasolina	4WD	2995	245	333	05.10-08.15	■	
3.6 FSI quattro		Gasolina	4WD	3597	206	280	08.06-05.10	■	
4.2 FSI quattro		Gasolina	4WD	4163	257	350	08.06-05.10	■	
3.0 TDI quattro	PR 1LF	Diesel	4WD	2967	150	204	11.10-08.15	■	
3.0 TDI quattro		Diesel	4WD	2967	155	211	03.06-05.10	■	
3.0 TDI quattro		Diesel	4WD	2967	171	232	03.06-05.08	■	
3.0 TDI quattro		Diesel	4WD	2967	176	240	11.07-05.12	■	
3.0 TDI quattro	PR 1LF	Diesel	4WD	2967	180	245	05.11-08.15	■	
4.2 TDI quattro		Diesel	4WD	4134	240	326	03.07-06.09	■	
4.2 TDI quattro	PR 1LF	Diesel	4WD	4134	250	340	03.07-08.15	■	
6.0 TDI quattro		Diesel	4WD	5934	368	500	09.08-05.14	■	

Q7 (4LB) 03.06-01.16						SUV (Luxury Crossover SUV-J Segment)			
3.0 TFSI quattro (CJTC)	PR 1LF	Gasolina	4WD	2995	200	272	05.10-08.15	■	
3.0 TFSI quattro (CJWC)	PR 1LF	Gasolina	4WD	2995	200	272	05.10-08.15	■	
3.0 TFSI quattro (CJWE)	PR 1LF	Gasolina	4WD	2995	206	280	05.11-08.15	■	
3.0 TFSI quattro (CTWB)	PR 1LF	Gasolina	4WD	2995	206	280	05.11-08.15	■	
3.0 TFSI quattro (CJTB)	PR 1LF	Gasolina	4WD	2995	245	333	05.10-08.15	■	
3.0 TFSI quattro (CJWB)	PR 1LF	Gasolina	4WD	2995	245	333	05.10-08.15	■	
3.0 TFSI quattro (CNAA)	PR 1LF	Gasolina	4WD	2995	245	333	05.10-08.15	■	
3.0 TFSI quattro (CTWA)	PR 1LF	Gasolina	4WD	2995	245	333	05.10-08.15	■	
3.6 FSI quattro (BHK)		Gasolina	4WD	3597	206	280	08.06-05.10	■	
4.2 FSI quattro (BAR)		Gasolina	4WD	4163	257	350	03.06-05.10	■	

# LISTA DE APLICACIONES - BUYERS GUIDE

3.0 TDI quattro (CJGC)	PR 1LF	Diesel	4WD	2967	150	204	05.10-08.15	■
3.0 TDI quattro (CJMA)	PR 1LF	Diesel	4WD	2967	150	204	05.10-08.15	■
3.0 TDI quattro (BUN)		Diesel	4WD	2967	155	211	03.06-05.10	■
3.0 TDI quattro (CASB)		Diesel	4WD	2967	155	211	03.06-05.10	■
3.0 TDI quattro (CATA)	PR 1LF	Diesel	4WD	2967	165	224	06.09-05.12	■
3.0 TDI quattro (BUG)		Diesel	4WD	2967	171	233	03.06-05.08	■
3.0 TDI quattro (CASA)		Diesel	4WD	2967	176	240	11.07-08.15	■
3.0 TDI quattro (CCMA)		Diesel	4WD	2967	176	240	11.07-08.15	■
3.0 TDI quattro (CJGA)		Diesel	4WD	2967	176	240	11.07-08.15	■
3.0 TDI quattro (CNRB)		Diesel	4WD	2967	176	240	11.07-08.15	■
3.0 TDI quattro (CJGD)	PR 1LF	Diesel	4WD	2967	180	245	05.11-08.15	■
3.0 TDI quattro (CLZB)	PR 1LF	Diesel	4WD	2967	180	245	05.11-08.15	■
3.0 TDI quattro (CRCA)	PR 1LF	Diesel	4WD	2967	180	245	05.11-08.15	■
4.2 TDI quattro (BTR)		Diesel	4WD	4134	240	326	03.07-06.09	■
4.2 TDI quattro (CCFA)	PR 1LF	Diesel	4WD	4134	250	340	05.09-08.15	■
4.2 TDI quattro (CCFC)	PR 1LF	Diesel	4WD	4134	250	340	05.09-08.15	■
6.0 TDI quattro (CCGA)		Diesel	4WD	5934	368	500	09.08-05.14	■

## PORSCHE

<b>CAYENNE I (9PA) 05.02-12.10</b>				<b>SUV (Luxury Crossover SUV-J Segment)</b>				
3.2 (M02.2Y)	Rim 18	Gasolina	4WD	3189	184	250	10.03-09.07	■
3.6 (M 55.01)	Rim 18	Gasolina	4WD	3598	213	290	02.07-09.10	■
S 4.5 (M 48.00)	Rim 18	Gasolina	4WD	4511	250	340	09.02-09.07	■
Turbo 4.5 (M 48.50)	Rim 18	Gasolina	4WD	4511	331	450	09.02-09.07	■
Turbo S 4.5 (M 48.50S)		Gasolina	4WD	4511	368	500	01.04-09.07	■
S 4.8 (M 48.01)	Rim 18	Gasolina	4WD	4806	283	385	02.07-09.10	■
GTS 4.8 (M 48.01)		Gasolina	4WD	4806	298	405	10.07-09.10	■

<b>CAYENNE II (92A) 05.10-</b>				<b>SUV (Luxury Crossover SUV-J Segment)</b>				
3.0S		Gasolina	4WD	2995	245	333	05.10-05.11	■
3.6 (M 55.02)		Gasolina	4WD	3598	220	300	06.10-12.18	■
3.6 (MCE.YA)		Gasolina	4WD	3598	220	300	06.10-12.18	■
4.8 S (M 48.02)		Gasolina	4WD	4806	294	400	06.10-05.14	■
4.8 Turbo (M 48.52)		Gasolina	4WD	4806	368	500	06.10-05.14	■
4.8 Turbo (M 48.52)		Gasolina	4WD	4806	397	540	06.10-05.14	■
3.0 S E-Hybrid (M 06.EC)		Gasol./el éc.	4WD	2995	306	416	05.11-05.17	■
3.0 S E-Hybrid (MCG.E)		Gasol./el éc.	4WD	2995	306	416	05.11-05.17	■
3.0 S E-Hybrid (MCG.EA)		Gasol./el éc.	4WD	2995	306	416	05.11-05.17	■
3.0 S E-Hybrid (MCG.FA)		Gasol./el éc.	4WD	2995	306	416	05.11-05.17	■
3.0 Diesel (MCR.CB)		Diesel	4WD	2967	155	211	06.10-05.18	■
3.0 Diesel (MCV.VC)		Diesel	4WD	2967	155	211	06.10-05.18	■
3.0 Diesel (M 05.9E)		Diesel	4WD	2967	176	239	06.10-05.18	■
3.0 Diesel (MCN.RB)		Diesel	4WD	2967	176	239	06.10-05.18	■
3.0 Diesel (MCR.C)		Diesel	4WD	2967	180	245	06.11-05.18	■
3.0 Diesel (MCR.CA)		Diesel	4WD	2967	180	245	06.11-05.18	■
3.0 Diesel (MCV.VB)		Diesel	4WD	2967	184	250	08.14-05.18	■
3.0 Diesel (MCV.VA)		Diesel	4WD	2967	193	262	10.14-05.18	■

## VW

<b>TOUAREG (7LA, 7L6, 7L7) 10.02-12.13</b>				<b>SUV (Luxury Crossover SUV-J Segment)</b>				
3.2 V6 (AZZ)	PR 1LF	Gasolina	4WD	3189	162	220	10.02-11.06	■

## LISTA DE APLICACIONES - BUYERS GUIDE

3.2 V6 (BAA)	PR 1LF	Gasolina	4WD	3189	162	220	10.02-11.06	■
3.2 V6 (BKJ)	PR 1LF	Gasolina	4WD	3189	162	220	10.02-11.06	■
3.2 V6 (BMV)	PR 1LF	Gasolina	4WD	3189	162	220	10.02-11.06	■
3.2 V6 (BMX)	PR 1LF	Gasolina	4WD	3189	162	220	10.02-11.06	■
3.2 V6 (BRJ)	PR 1LF	Gasolina	4WD	3189	162	220	10.02-11.06	■
3.2 V6 (BMV)	PR 1LF	Gasolina	4WD	3189	177	241	11.04-11.06	■
3.6 V6 FSI (BHK)	PR 1LF	Gasolina	4WD	3597	206	280	10.05-05.10	■
3.6 V6 FSI (BHL)	PR 1LF	Gasolina	4WD	3597	206	280	10.05-05.10	■
4.2 V8 FSI (BAR)	PR 1LF	Gasolina	4WD	4163	257	350	06.06-05.10	■
4.2 V8 (AXQ)	PR 1LF	Gasolina	4WD	4172	228	310	12.02-11.06	■
6.0 W12 (BJN)	PR 1LF	Gasolina	4WD	5998	331	450	08.04-05.10	■
6.0 W12 (CFRA)	PR 1LF	Gasolina	4WD	5998	331	450	08.04-05.10	■
2.5 R5 TDI (BLK)	PR 1LF	Diesel	4WD	2461	120	163	08.03-05.10	■
2.5 R5 TDI (BPD)	PR 1LF	Diesel	4WD	2461	120	163	08.03-05.10	■
2.5 R5 TDI (BAC)	PR 1LF	Diesel	4WD	2461	128	174	01.03-05.10	■
2.5 R5 TDI (BPE)	PR 1LF	Diesel	4WD	2461	128	174	01.03-05.10	■
3.0 TDI (BUN)	PR 1LF	Diesel	4WD	2967	155	211	04.06-05.10	■
3.0 TDI (CASB)	PR 1LF	Diesel	4WD	2967	155	211	04.06-05.10	■
3.0 V6 TDI (BKS)	PR 1LF	Diesel	4WD	2967	165	225	11.04-05.10	■
3.0 V6 TDI (CATA)	PR 1LF	Diesel	4WD	2967	165	225	11.04-05.10	■
3.0 V6 TDI (CASA)	PR 1LF	Diesel	4WD	2967	176	240	11.07-05.10	■
3.0 V6 TDI (CASC)	PR 1LF	Diesel	4WD	2967	176	240	11.07-05.10	■
5.0 V10 TDI (AYH)	PR 1LF	Diesel	4WD	4921	230	313	10.02-05.10	■
5.0 V10 TDI (BKW)	PR 1LF	Diesel	4WD	4921	230	313	10.02-05.10	■
5.0 V10 TDI (BLE)	PR 1LF	Diesel	4WD	4921	230	313	10.02-05.10	■
5.0 V10 TDI (BWF)	PR 1LF	Diesel	4WD	4921	230	313	10.02-05.10	■
5.0 R50 TDI (CBWA)	PR 1LF	Diesel	4WD	4921	257	350	08.07-05.10	■